

LUKA GNSS Receiver

User Manual



©2023 Tersus GNSS Inc. All rights reserved.

Sales Enquiry: sales@tersus-gnss.com

Technical Support: support@tersus-gnss.com

More details, please visit www.tersus-gnss.com

Revision History

Version	Revision Date	Change Summary
1.0	20230208	Initial Release
1.1	20230414	Update Figures
1.2	20230614	Update Section 3.1
1.3	20230810	Update Section 1.3.1
1.4	20231222	Update Section 3.1

LUKA GNSS Receiver User Agreement

Copyright © 2023 Tersus GNSS Inc.

CAUTION! Please read this notice carefully before using LUKA GNSS Receiver. Use of LUKA GNSS Receiver indicates acceptance of the terms and conditions of the User Agreement.

Thank you for using LUKA GNSS Receiver! This agreement is a legally binding contract between Tersus GNSS Inc. and you regarding the user of LUKA GNSS Receiver. Please read all the terms and conditions listed in the agreement carefully. Use of LUKA GNSS Receiver indicates that you have agreed to accept all of the terms of this Agreement. If you have any questions about the content of the terms of this Agreement, please contact Tersus GNSS Inc. If you do not agree to any of the terms and conditions of this Agreement, please do not proceed with the subsequent operations.

1. License

Tersus provides users with free licenses for Tersus software and related materials, for the purpose of product needs and improvement, when users use Tersus products. Tersus does not guarantee that the free license will not be changed. The license fee will be calculated according to the price published on Tersus official website <http://www.tersus-gnss.com>. Before you pay the license fee as agreed, Tersus will reserve the right not to provide you with Tersus software and related materials. Without the permission of Tersus, users are not allowed to resell it to a third party or use Tersus software and related materials to obtain income through other means in any way.

2. Proprietary Rights

The user agrees that Tersus software and related materials shall belong to Tersus, and Tersus retains exclusive ownership of the trademarks and service marks represented by its company name and logo and all of the

documentation related. The user agrees that all technologies, algorithms and processes contained in Tersus software constitute commercial secrets, and the user will protect them. User may not reverse engineer, decompile or disassemble the software, nor alter images used in the software and the documentation. The user are not allowed to copy, modify, and reproduce relevant information, no matter it is modified or translated into another language, unless the permission of Tersus is obtained. The user agrees that if the user violates this agreement, he will be liable for damages determined by the court.

3.Customer Service

According to the situation of users using LUKA GNSS Receiver, Tersus will continue to add features, improve performance and experience. Although it is the Tersus's customary practice to provide reasonable assistance and support in the use of Tersus products to customers, Tersus shall not be obligated to any user to provide technical assistance or support through this agreement, and may at Tersus's sole election charge a fee for customer service.

4.Update Policy

Tersus may regularly or irregularly, update the firmware of LUKA GNSS Receiver to add functions or fix issues. Tersus is not obliged to provide updates or modifications to any user, nor do we guarantee that that updates or modifications are fully in line with expectations.

5.Disclaimer

Tersus will try best to make that the function of LUKA GNSS Receiver run normally and the data calculation is correct, but Tersus does not guarantee that all functions of the LUKA GNSS Receiver meets the expectations, the data calculation is correct and the stability of the LUKA GNSS Receiver runs stably. Tersus and distributors will not be liable for any indirect, special, incidental, consequential or exemplary damages caused in any way.

6.Termination

This agreement is hereby terminated by mutual agreement or by any breach of any one or more provisions of this agreement by either party. In such cases, all rights of Tersus shall remain in force and effect. Any protected information data of user maintained on database shall upon notice to the user and at the discretion of Tersus may be destroyed.

7.Copyright

Tersus LUKA GNSS Receiver and related materials (including, but not limited to, any images, photographs, animations, video, audio, music or text incorporated into the LUKA GNSS Receiver), and all intellectual property rights associated with it, whether exists in a tangible media or in an electronic media is owned by Tersus. You may not remove or alter any trademark, logo, copyright and other proprietary notice in or on the products.

8.Other

Tersus has the right to amend all the contents of this agreement and product policy, and the right to interpret them within the scope of law.

This agreement will be effective once it is published, and Tersus has the right to modify the content of the agreement at any time, and the modified results will be published on the Tersus website. If you do not agree with the modifications made, you have the right to stop using LUKA GNSS Receiver. If the user continues to use, it is deemed that the user accepts the modifications.



The conclusion, implementation and interpretation of this agreement and the settlement of disputes shall be governed by the laws of China and subject to the jurisdiction of the Chinese courts. If any dispute arises between the parties regarding the content of this agreement or its implementation, the parties shall try to resolve it through friendly consultation; if consultation fails, either party may file a lawsuit in the court where Tersus GNSS is located.

Safety Information





Make sure that you have read and understood all safety requirements before you start using Tersus product.

Conventions

The following conventions are used in this manual:

!	Information that supplements or clarifies text.
	A caution that actions, operation or configuration may lead to incorrect or improper use of the hardware.
	A warning that actions, operation or configuration may result in regulatory noncompliance, safety issues or equipment damage.

The following notices apply to LUKA GNSS receivers.

	Operating or storing the receiver outside the specified temperature range can damage it.
	Changes or modifications to this equipment not expressly approved by Tersus could void the user's authority to operate this equipment or even has risk to damage the receivers.
	DO NOT use the receiver in a thunderstorm as there is increasing risk of being struck by lightning.
	Install the radio antenna before switching the radio transceiver to transmit mode, or the radio transceiver may be damaged due to overheating. The energy to be transmitted cannot be emitted out without the antenna, which may cause the temperature rise and overheat of the radio module.

**Safety: exposure to radio frequency (RF)**

Exposure to RF energy is an important safety consideration. Although our product is compliance with the safety standard released by various standard organizations, the following precautions are recommended to ensure low exposure to radio frequency radiation.

- DO NOT operate the transmitter when someone is within the following distances of the antenna:
 - Bluetooth, Wi-Fi, GSM/UTMS – less than 20cm
 - 410-470MHz UHF radio – less than 47cm
- DO NOT operate the transmitter unless all RF connectors are secured and any open connectors are properly terminated.
- DO NOT operate the equipment near electrical blasting caps or in an explosive atmosphere.
- All equipment must be properly grounded.
- All equipment should be serviced only by a qualified technician.

Notices

CE Marking

Tersus GNSS Inc. declares that LUKA GNSS receiver is in compliance with the essential requirements (radio performance, electromagnetic compatibility and electrical safety) and other relevant provisions of Radio Equipment Directive 2014/53/EU, Electromagnetic Compatibility (EMC) Directive 2014/30/EU, and Low voltage (LVD) Directive 2014/35/EU. Therefore the equipment is labeled with the following CE-marking.



The Declaration of Conformity may be obtained from Tersus GNSS Inc.

RCM Marking

Tersus GNSS Inc. declares that LUKA GNSS receiver is in compliance with the essential requirements (electrical safety, EMC, & telecommunications) from Australian & New Zealand RCM compliance requirements. Therefore the equipment is labeled with the following RCM-marking.



The Declaration of Conformity may be obtained from Tersus GNSS Inc.

Waste Electrical and Electronic Equipment (WEEE)

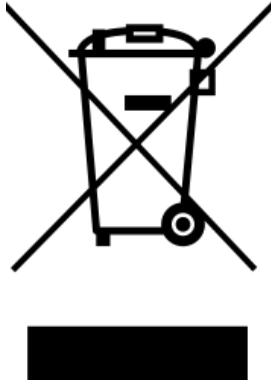

This product must not be disposed with household waste.

Dispose of the product appropriately in accordance with the national regulations in force in your country.

Always prevent access to the product by unauthorised personnel.

Product-specific treatment and waste management information can be received from your local Tersus distributor.

Related Documentation

Table 0.1 Document and software used in this user manual

Name	Description	Link
Tersus Tool Suite	Tersus Tools including TersusDownload, TersusGeoPix, TersusGNSSCenter, TersusUpdate, TersusRinexConverter	https://www.tersus-gnss.com/software
Nuwa	Survey application running in the Android platform, David, LUKA and other NMEA devices can be configured with Nuwa.	https://www.tersus-gnss.com/software/software
Tersus Geomatics Office	Post processing tool for static data.	https://www.tersus-gnss.com/software/software

Support

If there is any problem and the information needed cannot be found in the product documentation, log a technical support ticket in our tracking system

<https://tersus.supportsystem.com/> , or mail to support@tersus-gnss.com.

Table of Content

Revision History	2
LUKA GNSS Receiver User Agreement	3
Safety Information	6
Notices	8
Table of Content	11
List of Figures	13
List of Tables	16
1. Introduction	17
1.1 Overview	17
1.2 Receiver features	18
1.3 Devices in the package	19
1.3.1 LUKA GNSS receiver	19
1.3.2 Type-C to USB cable	23
1.3.3 Adapter	24
1.3.4 TC50 controller	25
1.3.5 External radio for LUKA	28
1.3.6 Other accessories	29
2. General Operations	34
2.1 Setting up LUKA	34
2.1.1 Insert the SIM card	34
2.1.2 Fix LUKA on a tripod or ranging pole	35
2.2 LUKA configuration	37
2.2.1 Configure via button	37
2.2.2 Configure via TC50 controller	37
2.3 Data download	43

2.3.1 Connection	43
2.3.2 Download static data	43
2.3.3 Download debug data	44
2.4 Firmware upgrade	45
2.5 Web UI	49
2.6 Operations of TC50 controller	54
2.6.1 Insert SIM card and SD card	54
2.6.2 Using of touch screen	55
3. Technical Specifications	56
3.1 LUKA GNSS receiver	56
3.2 TC50 controller	59
3.3 External radio for LUKA	60
3.4 Radio whip antenna	62
4. Typical Applications	63
4.1 Base station operation	64
4.2 Rover operation	70
4.3 Static survey	75
4.4 Tilt survey and stakeout	76
4.4.1 Tilt initialization	77
4.4.2 Tilt survey	78
4.4.3 Tilt stakeout	80
4.5 Issues and solutions	81
5. Terminology	85

List of Figures

Figure 1.1	LUKA GNSS receiver	19
Figure 1.2	Button and LEDs on LUKA GNSS receiver	20
Figure 1.3	Smart battery with power display	21
Figure 1.4	Bottom of LUKA GNSS receiver	22
Figure 1.5	Type-C to USB cable	23
Figure 1.6	Adapter for EU	24
Figure 1.7	Adapter for US	24
Figure 1.8	Adapter for UK	24
Figure 1.9	Adapter for AU	24
Figure 1.10	TC50 Controller	26
Figure 1.11	TC50 Lithium Battery	27
Figure 1.12	TC50 Charger	27
Figure 1.14	External radio for LUKA	28
Figure 1.15	High gain radio antenna	28
Figure 1.16	Telescopic pole for radio antenna	29
Figure 1.17	Serial-5pin to External-Radio-DC-5pin & Bullet-DC Cable	29
Figure 1.18	Stylus pen for TC20	29
Figure 1.19	GNSS antenna connector	30
Figure 1.20	Height measure accessory	30
Figure 1.21	Tape measure	30
Figure 1.22	410-470MHz radio whip antenna	31
Figure 1.23	Extension pole 30cm	31
Figure 1.24	Metal fixing plate	31
Figure 1.25	Ranging Pole	32
Figure 1.26	Bracket for TC50	32
Figure 1.27	Carrying Case	32

Figure 1.28	Tool bag	33
Figure 1.29	Configuration cable for 28W radio	33
Figure 2.1	Insert the SIM card	34
Figure 2.2	LUKA as a base without radio antenna	35
Figure 2.3	LUKA as a rover without radio antenna	36
Figure 2.4	Device functional group	37
Figure 2.5	Connect LUKA via Bluetooth	38
Figure 2.6	Device info of LUKA	39
Figure 2.7	eBubble before adjusting	39
Figure 2.8	eBubble after adjusting	40
Figure 2.9	Base configuration	41
Figure 2.10	Rover configuration	41
Figure 2.11	Link status of Base	42
Figure 2.12	Link status of Rover	42
Figure 2.13	Connect LUKA to a computer	43
Figure 2.14	Static record folder	44
Figure 2.15	Static data for one day	44
Figure 2.16	rtkmain.log file location	44
Figure 2.17	Debug info folders	45
Figure 2.18	Connect to LUKA via Bluetooth	46
Figure 2.19	View LUKA firmware version	46
Figure 2.20	connect the computer and LUKA	47
Figure 4.1	LUKA as a base - network mode	64
Figure 4.2	LUKA as a base - internal radio	65
Figure 4.3	LUKA as a base – external radio	66
Figure 4.4	Base setting interface	68
Figure 4.5	Base configuration - Receiver Network (TCS)	68
Figure 4.6	Base configuration – PDA Network (Ntrip)	69

Figure 4.7	Base configuration - Internal Radio	69
Figure 4.8	Base configuration - External Radio	69
Figure 4.9	Link status of base using internal radio	70
Figure 4.10	LUKA as a Rover - Network Mode	70
Figure 4.11	LUKA as a Rover - Internal Radio	71
Figure 4.12	Rover setting interface	73
Figure 4.13	Rover configuration - Internal Radio	73
Figure 4.14	Rover configuration - Receiver Network (TCS)	74
Figure 4.15	Rover configuration - Receiver Network (Ntrip)	74
Figure 4.16	Rover configuration - PDA Network (Ntrip)	74
Figure 4.17	Link status of Rover using internal radio	75
Figure 4.18	Static Survey configuration	76
Figure 4.19	Detailed information of tilt compensation	78
Figure 4.20	Tilt status is ON	79
Figure 4.21	Point stakeout when tilt compensation is on	80

List of Tables

Table 0.1	Document and software used in this user manual	9
Table 1.1	LED indicators	20
Table 1.2	Power display and button	21
Table 1.3	LED flash patterns	21
Table 1.4	Receiver ports on the bottom side	23
Table 2.1	Devices to set LUKA as a base without radio antenna	35
Table 2.2	Devices to set LUKA as a rover without radio antenna	36
Table 3.1	LUKA GNSS receiver performance	56
Table 3.2	Pin definition of the TNC connector	58
Table 3.3	Default factory configuration for internal radio	58
Table 3.4	Detailed configuration information for internal radio	58
Table 3.5	TC50 technical specification	59
Table 3.6	External radio RS400H3 technical specification	60
Table 3.7	Default factory configuration for Radio RS400H3	62
Table 3.8	Radio whip antenna technical specification	63
Table 4.1	Devices of LUKA as a base network mode	64
Table 4.2	Devices of LUKA as a base internal radio mode	65
Table 4.3	Devices of LUKA as a base external radio mode	66
Table 4.4	Devices of LUKA as a rover network mode	71
Table 4.5	Devices of LUKA as a rover internal radio mode	71

1. Introduction

This chapter includes overview, receiver features, and devices in the package.

1.1 Overview

The LUKA GNSS Receiver is a new generation GNSS RTK system, which is small and light, easy to carry and operate. It supports calibration-free tilt compensation function which is immune to magnetic disturbances, leveling pole is not required. With an internal high-performance multi-constellation and multi-frequency GNSS board, the LUKA GNSS Receiver can provide high accuracy and stable signal detection. The high-performance antenna can speed up the time to first fix (TTFF) and improve anti-jamming performance. The built-in 7000mAh large capacity battery supports up to 19 hours of field work in 4G/3G/2G network and Rover radio mode. The built-in UHF radio module supports long distance communication. The rugged housing protects the equipment from harsh environments.

There are four versions of the LUKA GNSS Receiver, which can provide selectivity for the requirement from different users.

1.2 Receiver features

The LUKA GNSS receiver has following features:

- Supports multiple constellations & frequencies
 - GPS L1, L2, L5
 - GLONASS L1, L2
 - BeiDou B1I, B2I, B3I, B1C, B2a
 - Galileo E1, E5a, E5b
 - QZSS L1, L2, L5
 - SBAS supports WAAS, EGNOS, GAGAN, SDCM, MSAS
- Supports 1568 channels.
- Supports 410-470MHz UHF radio⁽¹⁾, 4G network, Wi-Fi, Bluetooth, NFC
- Tilt compensation without calibration, immune to magnetic disturbances⁽¹⁾
- The whole design is exquisite and compact, which is more convenient to carry and operate
- 8GB internal storage
- Up to 19 hours working in 4G/3G/2G network and Rover radio mode⁽²⁾
- IP68-rated dust- & waterproof enclosure, for reliability in harsh environmental conditions
- Free subscription of Tersus Caster Service (TCS): transmit the correction data from LUKA Base to Rover

Note:

(1) IMU and built-in radio are optional.

(2) The working time of the battery is related to the working environment, working temperature and battery life.

1.3 Devices in the package

The devices in the package may vary according to the customer requirement. Here describes the major parts in the package.

1.3.1 LUKA GNSS receiver

The LUKA GNSS receiver shown as below.



Figure 1.1 LUKA GNSS receiver

Buttons

One button is equipped on each version of LUKA GNSS receiver.

: Power ON/OFF button. When the device is off, long press it for 2 seconds to power on the receiver. When the receiver is on, long press it for over 3 seconds to power off the receiver.

LED Indicators

Six LED indicators are for LUKA GNSS receiver, smart battery with power display on the bottom. The LEDs on the front panel indicate various operating conditions. The detailed LED Descriptions are shown in the tables below.

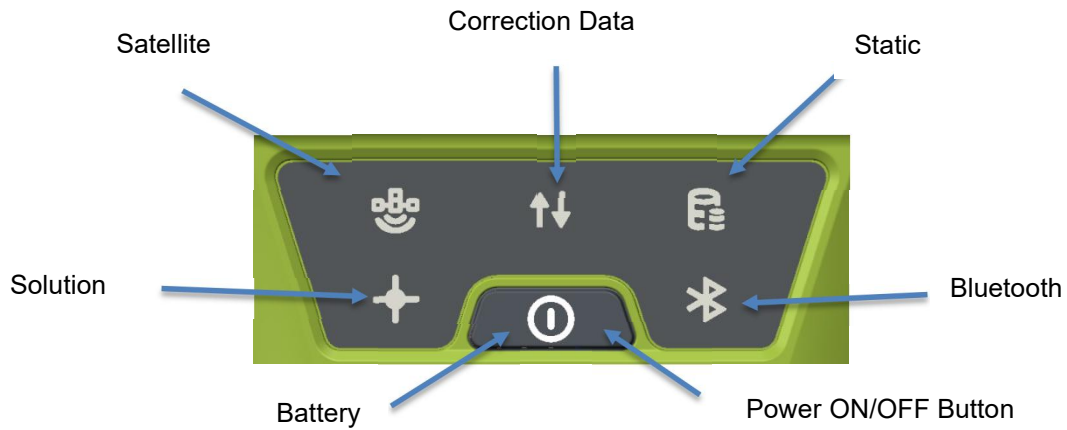







Figure 1.2 Button and LEDs on LUKA GNSS receiver

Table 1.1 LED indicators

LED indicator	Description
 Satellite	Green LED. Flashing every 5 seconds indicates that it is searching satellites. After satellites are searched, it flashes N times every 5 seconds, in which N indicates N satellites are found.
 Correction data	Green LED indicates correction data.
 Static Survey	Green LED indicates static survey mode.
 Solution status	Green LED. Steady green indicates fixed solution, flashing 1Hz indicates floating solution, off light for other solutions.
 Bluetooth	Green LED indicates Bluetooth status. Steady green indicates successful Bluetooth pair, off light indicates no Bluetooth paired.
 Battery	Green LED. Steady green in normal operation. Slow flash indicates the battery level is between 20% and 10%. Fast flash indicates the battery level is below 10% and reminds users to change battery.

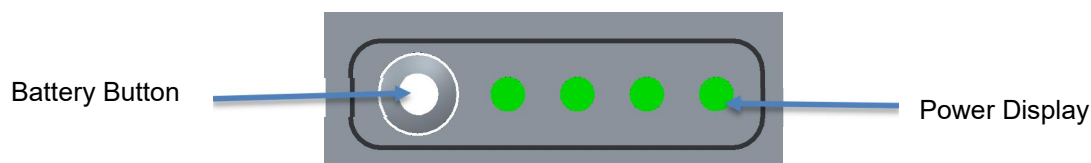

Figure 1.3 Smart battery with power display

Table 1.2 Power display and button

LED indicator	Description
Battery Button	After clicking the battery button, the green light will be on to display the current remaining power.
Power Display	Green LED. Under normal circumstances, one indicator represents 25% of the power. When charging, the green light flashes to display the current charging power.

LED Flash Patterns

The possible flash patterns of various states of receiver operation are listed in the table below.

Table 1.3 LED flash patterns

Receiver mode	Button operation	LED flash patterns
Receiver OFF	Long press the power button for 5s	All LEDs are off.
Receiver ON	Long press the power button for 2s	All LEDs are on, then all off, and each LED starts to indicate current status after initialization.
Low power	N/A	Battery LED flashes slow.
Battery exhausting	N/A	Battery LED flashes fast.
Searching satellites	N/A	Satellite LED flashes every 5s.
Satellites tracked	N/A	Satellite LED flashes N times every 5s, in which N is the quantity of satellites tracked.

Receiving valid data packet	N/A	Correction data LED flashes green at 1Hz.
Fixed solution	N/A	Solution status LED is steady green.
Floating solution	N/A	Solution status LED flashes green at 1Hz.
Firmware upgrade	N/A	all six LEDs are on for 3s thereafter only power LED lights up, then all LEDs light up and flashes in turn when upgrading, lights off when restarting. Then all six LEDs light up for 1s thereafter only power LED lights up means it restarts successfully with updated firmware.

Note: N/A means Not Applicable.

Receiver Ports

The bottom of LUKA receiver is shown as below.

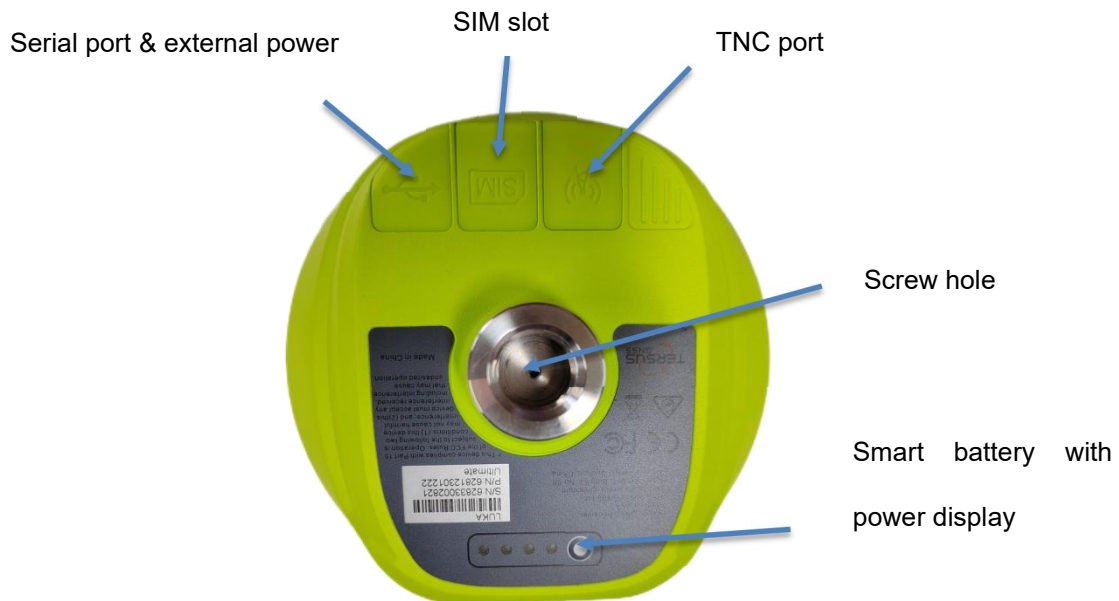



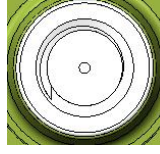

Figure 1.4 Bottom of LUKA GNSS receiver

Table 1.4 Receiver ports on the bottom side

Icon	Name	Connections
	Serial port & external power	Device, computer, USB drive, external power, communication, external radio
	SIM slot	Nano SIM card
	TNC port	410-470MHz radio antenna
	Screw hole	5/8" x 11 UNC-2B connector for corresponding connector and pole.

1.3.2 Type-C to USB cable

Functions:

1. Connect to the USB port of computer for data downloading;
2. Firmware upgrade, details refer to section 2.4;
3. Connect to the charger adapter to charge LUKA. Charge the battery completely before using LUKA for the first time. The charging takes approximately 3 hours at room temperature. If the battery has been stored for longer than three months, charge it before use.



Figure 1.5 Type-C to USB cable

1.3.3 Adapter

Connect to the Type-C cable to charge LUKA. The maximum power can reach 15W(5V 3A), realizing fast charging.



Figure 1.6 Adapter for EU



Figure 1.7 Adapter for US



Figure 1.8 Adapter for UK



Figure 1.9 Adapter for AU

EU: European, US: American, UK: British, AU: Australian

1.3.4 TC50 controller

The Tersus TC50 Controller is a rugged multi-functional data controller with design of 5 inch sunlight readable HD touch screen and an alphanumerical keypad. Equipped with powerful processor and android operating system, it is perfect to adapt with Tersus survey software. With professional IP68 rating, it is robust and reliable for harsh operating conditions. The large capacity lithium battery guarantees more than 10 hours of field working for a whole day of multiple surveying tasks.

Features:

- 5 inch sunlight readable HD touch screen
- Octa-core 2.0GHz CPU
- Android 8.1 operating system
- 4GB RAM + 64GB ROM
- 5MP front camera and 13MP rear camera
- IP68 certified grade, water/shock/dust proof
- 7000mAh battery
- Wi-Fi, Bluetooth, NFC, 4G
- USB Type-C

Note: Although the TC50 controller uses chemical and impact resistant materials, precision instruments require careful use and maintenance and should be kept as dry as possible. In order to improve the stability and life cycle of the TC50 controller, avoid exposing the TC50 controller to extreme environments such as moisture, high temperatures, low temperatures, corrosive liquids or gases.



TC50 must be in the specified temperature range -20 °C ~ 55 °C when

	used and stored.
--	------------------

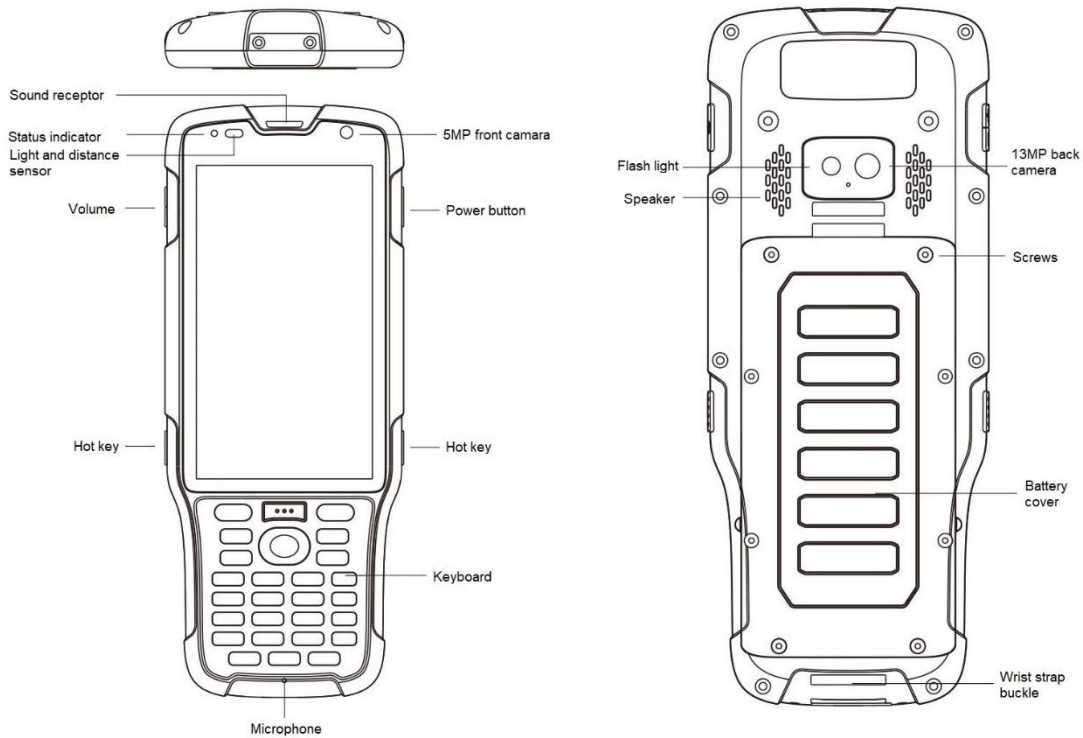

Figure 1.10 TC50 Controller

Power on: Press and hold the power button for 3 seconds

Power off: Press and hold the power button for 3 seconds, select 'Power Off' in the menu option.

Reboot: Press and hold the power button for 2 seconds and click "Restart" in the menu option.

Forced restart: Press and hold the power button for 8 seconds to force the controller to restart.

Introduction of functional keys:

- **Menu Key:** Select to show applications that was used recently.
- **Home Key:** Return to home screen. To view recent application, press and hold the home key.
- **Back Key:** Return to previous screen.

- **APP Key:** Quick start Nuwa application.
 - **Blue Positioning  Key:** Perform the function of starting measurement in the Survey and Stakeout interface of Nuwa application.
 - **Yellow Bulb Key:** Control the screen on and off.
- ENTER Key:** Execute the function of confirming in Nuwa application.

The accessories of TC50 Controller are listed below.

TC50 Lithium Battery (3.8V/7000mAh)

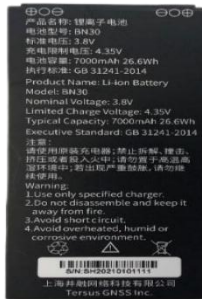

Figure 1.11 TC50 Lithium Battery

TC50 Charger (5V/1.67A, 7V/1.67A, 9V/1.67A)



Figure 1.12 TC50 Charger

Type-C Cable



Figure 1.13 Type-C cable

Functions:

1. Connect to the USB port of computer for data downloading;
2. Connect to the charger to charge TC50 controller.

1.3.5 External radio for LUKA

The external radio RS400H3 for LUKA below is to be installed via serial data port, and it can help LUKA transmitting signals farther than internal radio.



Figure 1.14 External radio for LUKA

When using external radio for LUKA as a base, a high gain radio antenna and a telescopic pole are needed which are shown as below.



Figure 1.15 High gain radio antenna



Figure 1.16 Telescopic pole for radio antenna

The following Serial-5pin to External-Radio-DC-5pin & Bullet-DC Cable and Bullet-DC to Alligator Clips are used to communicate with LUKA and connect to external power supply.



Figure 1.17 Serial-5pin to External-Radio-DC-5pin & Bullet-DC Cable



Figure 1.18 Stylus pen for TC20

1.3.6 Other accessories

Other accessories may be packed according to customer requirements.

The GNSS antenna connector is used to install LUKA to a tripod.



Figure 1.19 GNSS antenna connector

The height measure accessory is used to determine the height of LUKA with higher accuracy.



Figure 1.20 Height measure accessory

The tape measure below is to help measure height.



Figure 1.21 Tape measure

The 410-470MHz radio whip antenna is to be installed on the TNC port to transmit or receive signal for the internal radio.



Figure 1.22 410-470MHz radio whip antenna

When installing 410-470MHz radio whip antenna on LUKA, it is necessary to use a 30cm extension pole to heighten LUKA and avoid bending the 410-470MHz radio whip antenna.



Figure 1.23 Extension pole 30cm

This metal fixing plate is used to fixate the high gain radio antenna to the tripod.



Figure 1.24 Metal fixing plate

When using LUKA as a rover, you need a ranging pole.



Figure 1.25 Ranging Pole

The bracket for TC20 controller is to fix the TC50 controller on a ranging pole.



Figure 1.26 Bracket for TC50

A yellow carrying case is to store all the devices and accessories except ranging pole, high gain radio antenna and telescopic pole.



Figure 1.27 Carrying Case

The tool bag below is to store high gain radio antenna and telescopic pole for radio antenna.



Figure 1.28 Tool bag

The configuration cable for external radio RS400H3 below is used to configure parameters of the 28W radio instead of the default setting.



Figure 1.29 Configuration cable for 28W radio

2. General Operations

This chapter includes setting up, configuration and other related operations.

2.1 Setting up LUKA

2.1.1 Insert the SIM card

When 4G/3G/2G network is chosen for survey operation, you need to insert a nano SIM card into LUKA GNSS receiver. Insert the nano SIM card with the contacts facing outside which is shown as below.



Figure 2.1 Insert the SIM card

To eject the nano SIM card, slightly push it in to trigger the spring-loaded release mechanism.

Note: The SIM card is provided by your cellular network service provider.

2.1.2 Fix LUKA on a tripod or ranging pole

LUKA GNSS receiver has a standard 5/8" x 11 UNC-2B connector and it can be fixed on a tripod or a ranging pole to be a base or rover according to customer requirement.



Figure 2.2 LUKA as a base without radio antenna

Table 2.1 Devices to set LUKA as a base without radio antenna

Device Name	Quantity	Items in the figure
LUKA GNSS receiver	1	1, details refer to section 1.3.1
Height measure accessory	1	2, details refer to section 1.3.6
GNSS antenna connector	1	3, details refer to section 1.3.6
Tribrach	1	4
Tripod	1	5



Figure 2.3 LUKA as a rover without radio antenna

Table 2.2 Devices to set LUKA as a rover without radio antenna

Device Name	Quantity	Items in the figure
LUKA GNSS receiver	1	1, details refer to section 1.3.1
Ranging pole	1	2, details refer to section 1.3.6
Bracket for TC50	1	3, details refer to section 1.3.6
TC50 Controller	1	4, details refer to section 1.3.4

2.2 LUKA configuration

You can configure LUKA GNSS receiver via button, TC50 controller or other android devices.

2.2.1 Configure via button

The detailed definition and configuration of button on LUKA GNSS receiver refers to section 1.3.1.

2.2.2 Configure via TC50 controller

The detailed introduction of TC50 controller refers to section 1.3.4 and technical specification refers section 3.2. Here in this section describes how to configure LUKA via Nuwa app which is installed in TC50 controller.

2.2.2.1 Connect LUKA in Nuwa

The general operations of Nuwa app refer to *User Manual for Nuwa App* which can be downloaded on Tersus official website.

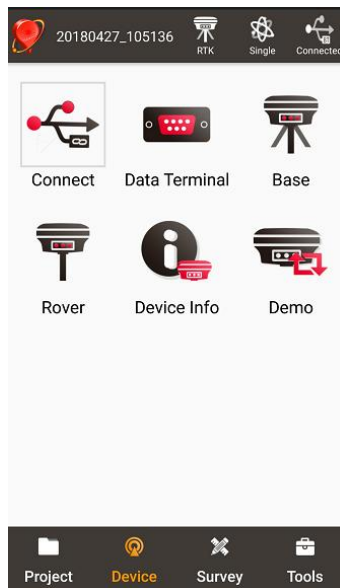

Figure 2.4 Device functional group

When LUKA GNSS receiver is powered on, to connect LUKA, put TC50 controller near the NFC logo on LUKA, the TC50 controller pair Bluetooth with LUKA automatically; or click [Device] -> [Connect] under an opened project, and select [LUKA] for the Device Type which is shown as below.

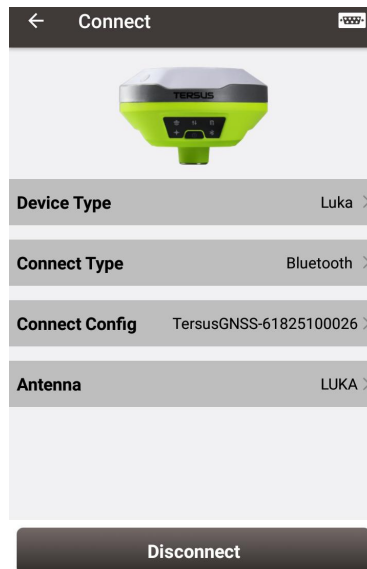



Figure 2.5 Connect LUKA via Bluetooth

Select [Bluetooth] for the Connect Type. Click [Connect Config] to search and pair the Bluetooth address of LUKA. The antenna is selected as [LUKA] by default. Then click [Connect] to enable the communication between TC50 controller and LUKA.

2.2.2.2 Electronic Bubble (eBubble)

Make the body of LUKA stand on a leveled Tribrach before eBubble calibration.

Click the device information icon  on the top tool bar of Nuwa, the LUKA info is shown as below.

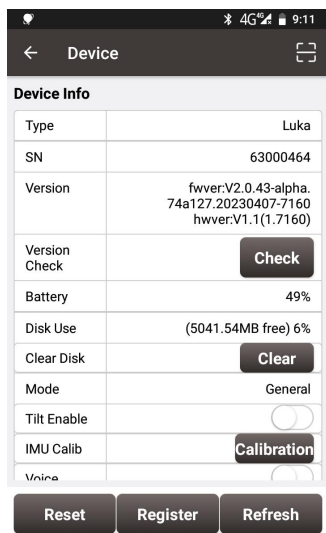

Figure 2.6 Device info of LUKA

Click **Adjust** on the right of electronic bubble to adjust bubble. On the screenshot below, the eBubble is not in the black circle and its color is red for warning purpose.

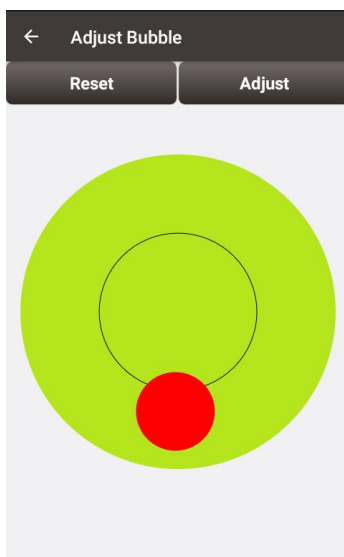

Figure 2.7 eBubble before adjusting

Click **Adjust** on the right, the eBubble is calibrated to the center inside the black circle and the bubble color turns blue.

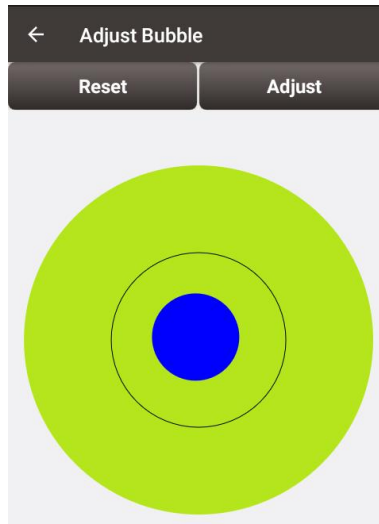

Figure 2.8 eBubble after adjusting

2.2.2.3 Registration

When the registration is not effective, follow below steps to complete the registration by using QR code.

Click the scan button at the top right of the device information interface and directly scan the QR code provided by Tersus to complete the registration.

2.2.2.4 Configure base or rover

To configure LUKA as a base or rover, back to Device interface which is shown in Figure 2.4 Device functional group, click [Base] or [Rover], then create a work mode of detailed configurations for base or rover which are shown as below.

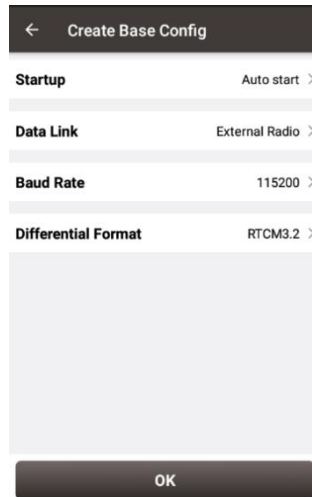

Figure 2.9 Base configuration

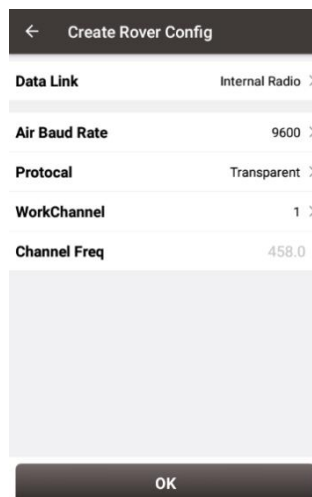

Figure 2.10 Rover configuration

Fill in the detailed information of base configuration or rover configuration, then click [OK] and back to the work mode list, select this configuration to start data transmission for base or rover which are shown as below.

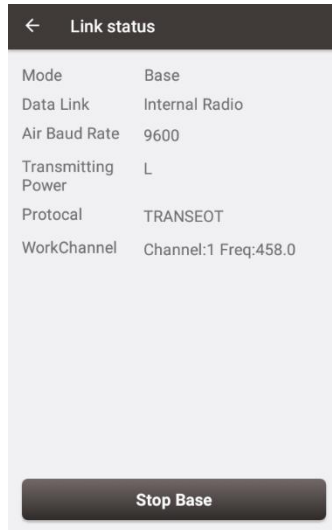

Figure 2.11 Link status of Base

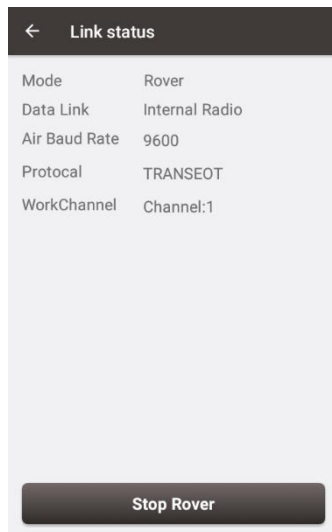

Figure 2.12 Link status of Rover

2.3 Data download

2.3.1 Connection

LUKA can be used as an USB storage device when connecting with a computer. Before connecting LUKA to a computer, ensure LUKA is powered on. Use the Type-C to USB cable in the package to connect LUKA to the USB port of a computer which is shown as below.

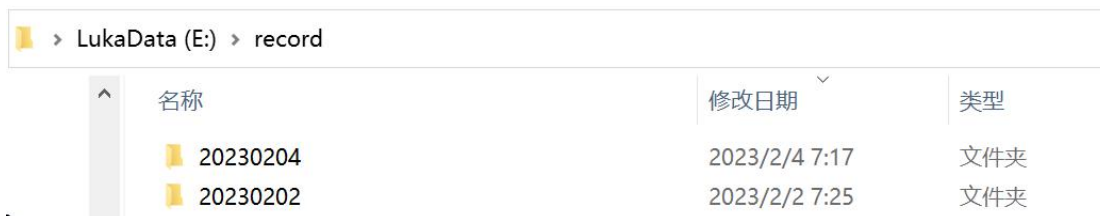

Figure 2.13 Connect LUKA to a computer

After completing the connection, a USB device is listed in the file browser of the computer. Find the data file needed to download, copy and paste it to a designated folder in your computer.

2.3.2 Download static data

If you want to download the recorded static data for post processing, find record folder shown as below, and then copy the specific file you need to your computer.



名称	修改日期	类型
20230204	2023/2/4 7:17	文件夹
20230202	2023/2/2 7:25	文件夹

Figure 2.14 Static record folder

Each folder named after the date contains rinex format and tersus binary data, which can be downloaded and processed as you need.

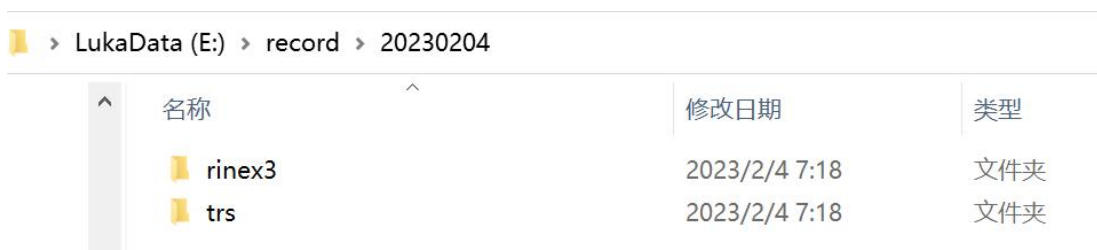

名称	修改日期	类型
rinex3	2023/2/4 7:18	文件夹
trs	2023/2/4 7:18	文件夹

Figure 2.15 Static data for one day

2.3.3 Download debug data

When you don't turn on the debug mode, find debug\LOG folder and you can see rtkmain.log file which includes all the operation information of the receiver.



名称	修改日期	类型	大小
rtkmain_2	2023/2/6 9:58	LOG 文件	1,800 KB
update	2023/2/6 9:57	LOG 文件	3 KB
rtkmain_1	2023/2/2 14:32	LOG 文件	66,045 KB

Figure 2.16 rtkmain.log file location

To turn on the debug mode, you can click [Device] -> [Device Debug] -> [Set] in Nuwa app. The debug information includes GNSS, tilt, internal radio and

NTRIP information. Select the debug info you want to record and turn on the debug mode. After you select some debug info to turn on and confirm, LUKA will record them when you are doing survey work.

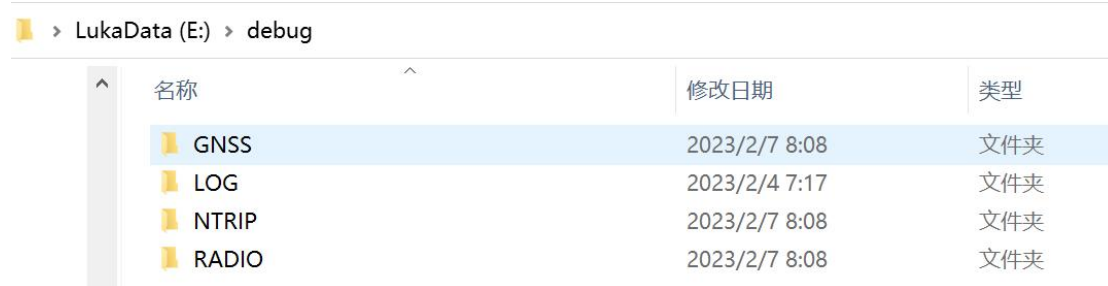

名称	修改日期	类型
GNSS	2023/2/7 8:08	文件夹
LOG	2023/2/4 7:17	文件夹
NTRIP	2023/2/7 8:08	文件夹
RADIO	2023/2/7 8:08	文件夹

Figure 2.17 Debug info folders

Send these debug info to Tersus technical support team to help solve the problems you encountered.

2.4 Firmware upgrade

View LUKA firmware version. When LUKA GNSS receiver is powered on, to connect LUKA, put controller near the NFC logo on LUKA, the controller pair Bluetooth with LUKA automatically; or click [Device] -> [Connect] under an opened project, and select [LUKA] for the Device Type, select [Bluetooth] for the Connect Type. Click [Connect Config] to search and pair the Bluetooth address of LUKA. The antenna is selected as [LUKA] by default. Then click [Connect] to enable the communication between controller and LUKA.

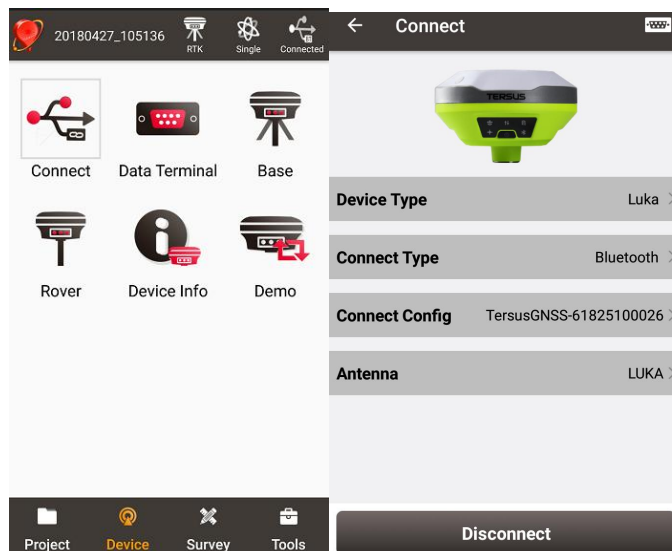



Figure 2.18 Connect to LUKA via Bluetooth

Click the device information icon  on the top tool bar of Nuwa, the LUKA info is shown as below. You can view LUKA firmware version.

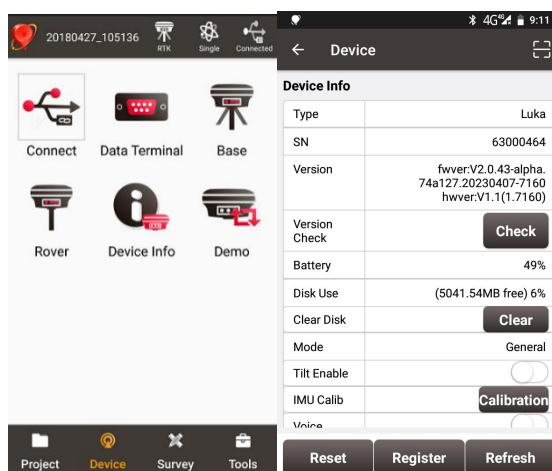

Figure 2.19 View LUKA firmware version

The detailed steps are as follows.

- 1) Download the latest firmware file from Tersus website <https://www.tersus-gnss.com/software/LUKA-gnss-receiver>.

Please be noted that the downloaded file is a .zip file, unzip this file to find the firmware file of .BIN format.

2) Prepare a Type-C to USB cable, when LUKA is turned on, connect the Type-C port of LUKA to the computer with a Type-C to USB cable.



Figure 2.20 connect the computer and LUKA

3) The computer interface will automatically pop up two removable disks. As shown in the figure below.



Figure 2.21 Two Removable Disks

4) Choose the LUKAUpdate removable disk and put the firmware file in the .BIN format on this removable disk. As shown in the figure below.



Figure 2.22 The FW is placed in the LUKAUpdate removable disk

5) Unplug the Type-C to USB cable, press and hold the power button for 3 seconds to shut down LUKA .

6) Make sure that LUKA is turned off, then press and hold the power button for 2 seconds to turn on LUKA.

When the six indicators on the LED panel are all on, the boot is successful,

release the power button. LUKA enters the upgrade mode when the six indicators on the LED panel are all on again, and waits for the upgrade to complete.



Figure 2.23 Upgrading

After the firmware upgrade is completed, the power LED light is on and the satellite light flashes. At this time, you can check the LUKA firmware version. If it is consistent with the latest firmware version in the removable disk, the firmware upgrade is successful.

Note: Please make sure the battery has enough power for the firmware upgrade. The GNSS board inside LUKA will upgrade when the firmware is upgrading, any forced power failure will cause the system crash.

2.5 Web UI

LUKA GNSS receiver supports being a Wi-Fi hot spot and connect with a computer or a smart terminal within five meters. You can read coordinate information, configure the receiver and upgrade the firmware through the web UI (user interface) on the browser of the computer or the smart terminal.

Follow below steps to enter the web user interface on a computer with Windows 10 operating system.

a. Upgrade the receiver to the latest firmware, and then open Wi-Fi .

Switch to [Device] -- [WIFI Setting] -- [Set] -- [Mode Config], select [AP] -- [confirm] via NUWA, as shown below.

Note: the version of NUWA app must be upgraded to V2.3.3 or above.

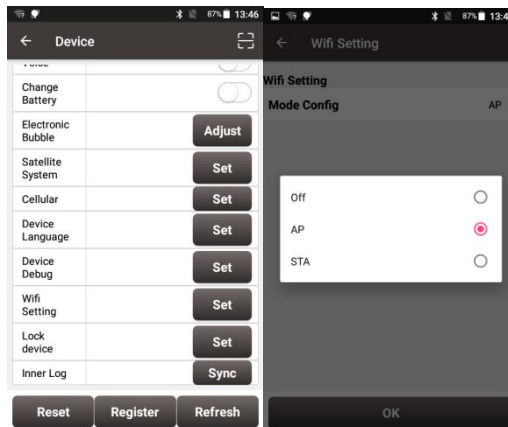

Figure 2.24 WiFi interface

b. Click the Internet connection icon on the lower right corner of the desktop. Turn on Wi-Fi connection and search the SSID of LUKA GNSS receiver which is composed of TersusGNSS and an eight digit number such as below. Click [Connect] to complete the Wi-Fi connection.

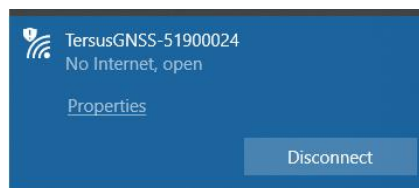

Figure 2.25 Make Wi-Fi connection

- c. Open a web browser and type 192.168.2.1 in the address bar. Type “admin” for the username and password, then click [Sign in] to enter the web UI.

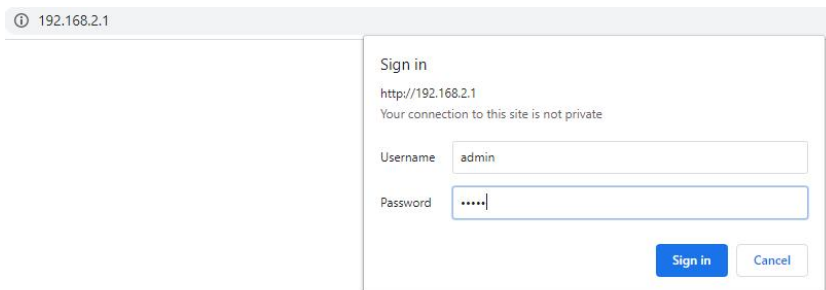

Figure 2.26 Sign in the web UI

- d. When you entered the web UI of LUKA GNSS receiver, you can see five tabs on the left and make corresponding operations such as view positioning info, view satellites info, make device settings, make connectivity settings, and upgrade firmware. [Satellites Info] - [Position Info] - view position information.

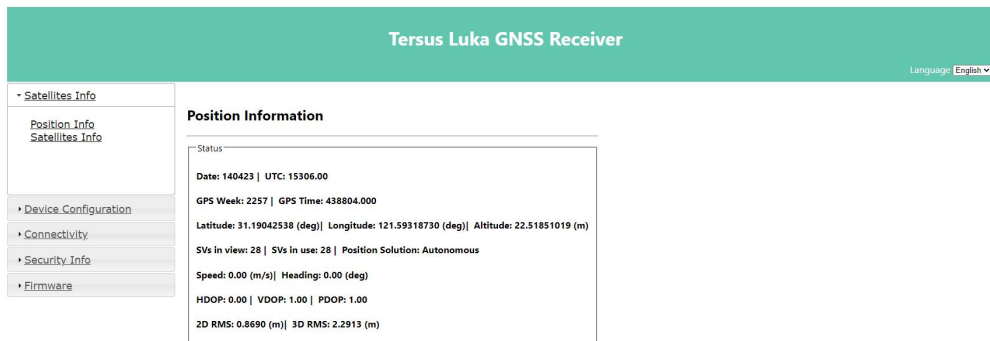

Figure 2.27 Main interface of LUKA's web UI

- e. configure the working mode and related parameters of the equipment . [Device Configuration] - [Mode Configuration] - select working mode - next - next - set.

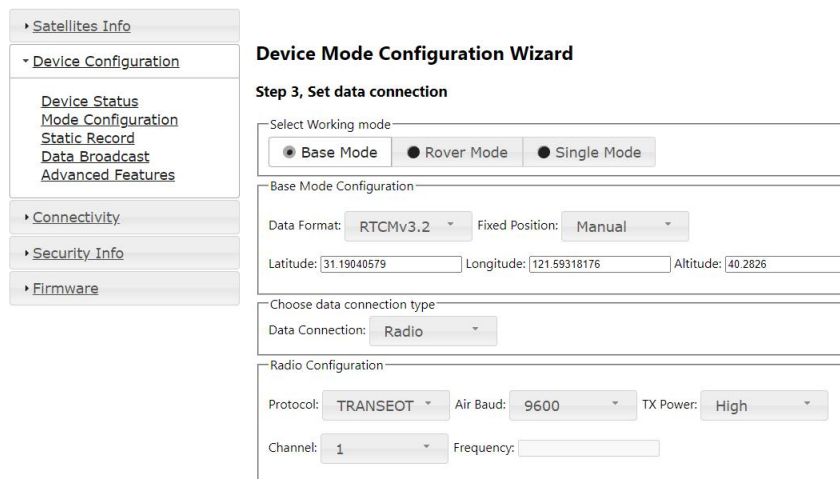

Figure 2.28 configure a working mode

f. configure NMEA data output.

[Device Configuration] - [Advanced Features] - select tilt correction result output - select NMEA data output - select localized coordinates output - set.

In Tilt Correction Configuration, turn on tilt mode and make sure the pole height is correct, then turn on Tilt Correction On GGA, the GGA messages will no longer record the coordinates of the phase center of the antenna in the tilted state, but the coordinates of the virtual phase center assuming that the pole is vertical.

In NMEAout Settings, the configuration of the NMEA messages output frequency will take effect for both serial output and Bluetooth output.

In Localized Coordinates Configuration, select your local coordinate system, and the localized coordinates will be output in NMEA PJK messages.

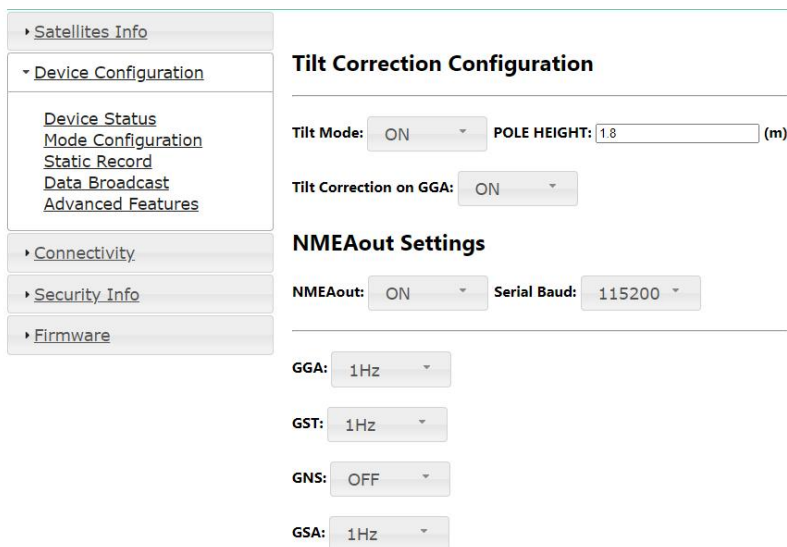

Figure 2.29 configure NMEA data output

g. configure connectivity.

[Connectivity] - [Cellular Network] - enter APN Name - set.

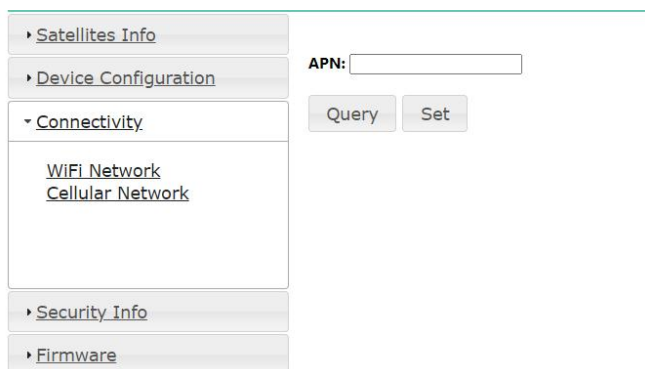

Figure 2.30 configure connectivity

h. upgrade device firmware version via web page. [Firmware] - [Firmware Info] - [Firmware Upgrade] - click to select the file- click [upgrade].

you can use this function to upgrade after the next official version is released.

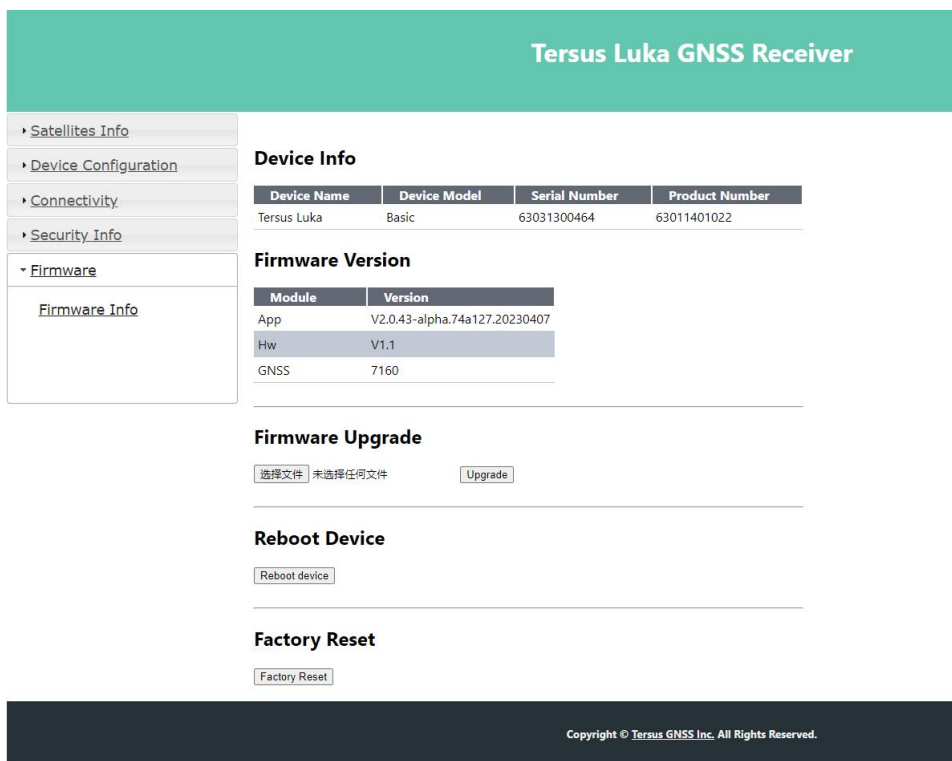

Figure 2.31 upgrade the firmware

i. manage user logins through web pages.

[Security Info] - [Account Info] - [Add User] - [Add User Dialog] - input Login Name&Alias Name&Password.

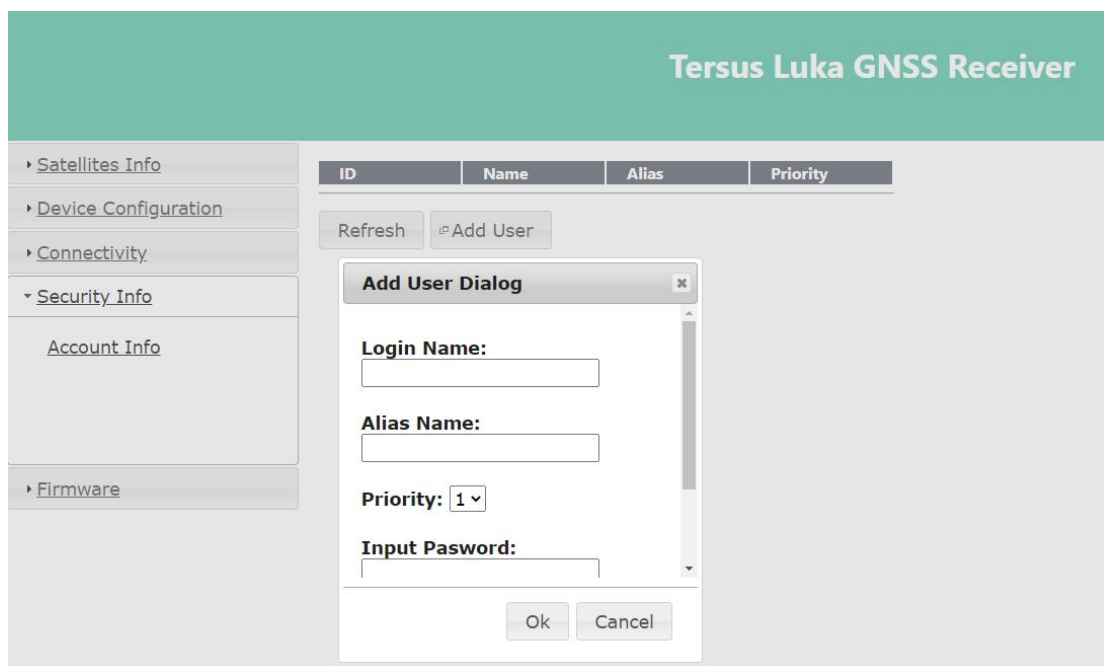

Figure 2.32 add user login

2.6 Operations of TC50 controller

2.6.1 Insert SIM card and SD card

Please note the direction of the card notch when inserting the card, inserting a non-standard card may cause damage to the SIM card slot of the controller.

The controller cannot support two CDMA cards at the same time, when two CDMA cards are installed at the same time, only one card can use the 4G network, the other card will not be able to register the network.

To install the SIM card you need to open the battery cover, remove the battery and open the SIM card cover.

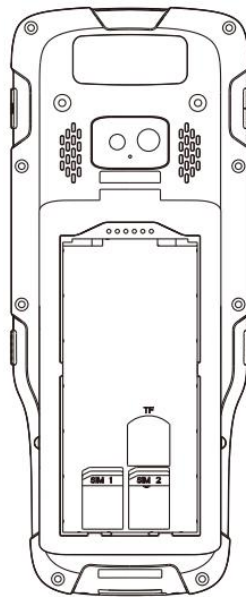

Figure 2.33 Install the SIM card

Note: Please power off the controller before plug in or pull out the SIM card.

2.6.2 Using of touch screen

Single Click: To select an icon. For example, click dial to open the keypad which will be displayed on the screen.

Double Click: To zoom-in or zoom-out. For example, to zoom-in or out of a photo, click twice when viewing a photo or browsing on the internet.

Hold: press and hold the screen, icon or input box to get more operation options.

a) Long-Time Click a picture in the gallery list interface, the status bar prompts to select a picture, you select to share or delete it.

b) Long-Time Click the blanks of home screen to add home screen widgets.

c) Long-Time Click the blanks of home screen wallpaper sources can be selected.

d) Long-Time Click the blanks of home screen to home settings.

Slide Upward: Slide up on the main screen (or click the upward arrow icon) to view more applications.

Slide Downward: Slide down on any interface to open the status bar and message board.

Slide Left and Right: Slide left and right on the main screen to switch the desktop interface.

3. Technical Specifications

This chapter mainly introduces the technical specifications of LUKA GNSS receiver, TC50 Controller, external radio and internal radio whip antenna.

3.1 LUKA GNSS receiver

Table 3.1 LUKA GNSS receiver performance

GNSS Performance		
Position accuracy(RMS)	Single Point Positioning	1.5m (Horizontal)
		2.5m (Vertical)
	DGPS Positioning	0.25m (Horizontal)
		0.5m (Vertical)
	High Precision Static	2.5mm+0.1ppm (Horizontal)
		3.5mm+0.4ppm (Vertical)
	Static & Fast Static	2.5mm+0.5ppm (Horizontal)
		5mm+0.5ppm (Vertical)
	Post Processed Kinematic	2.5mm+1ppm (Horizontal)
		5mm+1ppm (Vertical)
Real Time Kinematic	8mm+1ppm (Horizontal)	
	15mm+1ppm (Vertical)	
Network Real Time Kinematic	8mm+0.5ppm (Horizontal)	
	15mm+0.5ppm (Vertical)	
Observation accuracy (zenith direction)	C/A code	10cm
	P code	10cm
	Carrier phase	1mm
Time To First Fix (TTFF)	Cold start	<30s
	Warm start	<5s
Reacquisition	<1s	
Tilt compensation accuracy (within 60°)	≤2cm	
Timing accuracy (RMS)	20ns	
Velocity accuracy (RMS)	0.03m/s	
Initialization (typical)	4s	
Initialization reliability	>99.9%	
System & Data		
Operating system	Linux	
Storage	built-in 8GB	

Data format	CMR, RTCM 2.3, RTCM3.x	
Data output	RINEX, NMEA-0183, Tersus Binary	
Data output rate	20Hz	
Software Support		
Tersus Nuwa		
Communication		
Cellular	4G LTE/WCDMA/GSM/EDG	
Cellular bands	LTE FDD B1,B3,B7,B8,B20,B28A LTE TDD B38,B40,B41 WCDMA B1,B8 GSM/EDGE B3,B8	
Network protocols	Ntrip Client, Ntrip Server, TCP, Tersus Caster Service (TCS)	
Wi-Fi	802.11b/g/n	
Bluetooth	4.1	
Internal radio	RF transmit power	0.5W/1.0W
	Frequency	410MHz ~ 470MHz
	Operating mode	Half-duplex
	Channel spacing	12.5KHz / 25KHz
	Modulation type	GMSK, 4FSK
	Air baud rate	4800/9600/19200 bps
	Radio protocols	TrimTalk450, TrimMark 3, South, Transparent, Satel
USB	Type-C, OTG x1	
User Interface		
Button	Power button	
LED indicators	Satellite, Correction data, Static, Solution, Bluetooth	
Voice	Support in Nuwa App	
Power display	Support	
Electrical		
External power supply	Support USB (5~20V)	
Fast charging	Support, 15W max(5V 3A)	
Lithium battery	7000mAh/7.4V	
Charing time	3 hours (20%~90%)	
Battery charging temperature:	+10°C ~ +45°C	
Battery working time	Up to 19 hours	
Physical		
Dimension	φ132x68mm	
Weight	≈827g	
Screw hole for assembly	5/8"x11UNC-2B	
Vibration	MIL-STD-810G,FIG.514.6C-1	
Environmental		

Operating temperature	-40°C to +70°C
Storage temperature	-55°C to +85°C
Relative humidity	100% not condensed
Water & dust proof	IP68
Pole drop onto concrete	2m

The pin definition of the TNC connector is as below:

Table 3.2 Pin definition of the TNC connector

Connector Pin No.	Pin Definition
Inside	Signal
Outside	Ground

Table 3.3 Default factory configuration for internal radio

Channel	Frequency
00	457.550MHz
01	458.050MHz
02	458.550MHz
03	459.050MHz
04	459.550MHz
05	460.550MHz
06	461.550MHz
07	462.550MHz
08	463.550MHz
09	464.550MHz
Customized frequency	410~470MHz

Table 3.4 Detailed configuration information for internal radio

Protocol	Modulation type	Channel band	Air baud rate	COM baud rate
TrimTalk450	GMSK	12.5 KHz	4800 bps	9600/19200/38400/115200bps
	GMSK	25 KHz	9600 bps	9600/19200/38400/115200bps
TrimMark3	GMSK	50 KHz	19200 bps	9600/19200/38400/115200bps
Transparent	GMSK	12.5 KHz	4800 bps	9600/19200/38400/115200bps
	GMSK	25 KHz	9600 bps	9600/19200/38400/115200bps

Satel	4FSK	12.5 KHz	9600 bps	9600/19200/38400/115200bps
	4FSK	25 KHz	19200 bps	9600/19200/38400/115200bps
South	GMSK	12.5 KHz	4800 bps	9600/19200/38400/115200bps
	GMSK	25 KHz	9600 bps	9600/19200/38400/115200bps
	GMSK	50 KHz	19200 bps	9600/19200/38400/115200bps

3.2 TC50 controller

Table 3.5 TC50 technical specification

System	
Operating System	Android 8.1
CPU	MT6763 Octa-Core 2.0GHz
Memory	4GB RAM + 64GB ROM
External storage	Micro SD, up to 128GB
Display	5" sunlight-readable capacitive touch screen
Resolution	720x1280
Camera	5MP front, 13MP rear
Flash Light	High light Flash LED
Electrical	
Battery	7000mAh 3.8V
Battery Life	14 hours
Charging Time	<4 hours (fast charge)
Communication	
Wi-Fi	IEEE 802.11a/b/g/n 2.4G&5G
Cellular Mode	Dual SIM Dual Standby
SIM1 & SIM2	FDD-LTE B1/B3/B5/B7/B8 TD-LTE B38/B39/B40/B41 TDSCDMA B34/B39 WCDMA B1/B2/B5/B8 CDMA1x/CDMA2000 BC0/BC1 GSM B2/B3/B5/B8
Bluetooth	BT4.1 (BLE)

USB	USB Type-C (supports OTG)
NFC	Protocol of ISO14443A/B, and ISO15693 Readable Distance 0~5cm
GNSS	GPS/GLONASS/BeiDou
Sensors:	G-Sensor, Compass, Light-Sensor, Gyro
Physical	
Dimension	207mmx84mmx20mm
Weight	370g (include battery)
Reliability	
Operating Temperature	-20°C ~ +55°C
Storage Temperature	-30°C ~ +70°C
Humidity	5% ~ 95%
Dustproof & Waterproof	IP68
Shock	1.5m drop onto concrete

3.3 External radio for LUKA

Table 3.6 External radio RS400H3 technical specification

General Specification		
Frequency range	410~470MHz	
Operating mode	Simplex	
Channel width	25KHz, 12.5KHz	
Modulation Type	GMSK/4FSK	
Operating voltage	9~16V DC	
Power consumption	High power (28W)	78W @ DC 12V
	Medium power (22W)	60W @ DC 12V
	Low power (5W)	35W @ DC 12V
	Standby	2W @ DC 12V
Frequency stability	≤ ±1.0ppm	
Transmitter		
RF output power	High level (28W)	44.5±0.5dBm @ DC 12V
	Medium level (22W)	43.4±0.5dBm @ DC 12V
	Low level (5W)	37±1dBm @ DC 12V
Power stability	±1dBm	
Adjacent channel power	>50dB	
Distance(Typical)	14-16KM	
Antenna		

Antenna Impedance	50 Ohm	
Antenna Interface	TNC female	
Modem		
Air baud rate	4800bps, 9600bps, 19200bps	
Modulation Type	GMSK/4FSK	
Serial port baud rate	9600bps, 19200bps, 38400bps, 57600bps, 115200bps	
Protocol	TRIMTALK, TRIMMK3, TRANSEOT, SOUTH, SATEL	
Environmental		
Temperature	Operating	-40 ~ +65°C
	Storage	-50 ~ +85°C
Dustproof and waterproof	IP67	
Physical Description		
Dimension	175 x 130 x 86.5 mm	
Weight	About 2.0kg	
Data & Power interface	LEMO 5pin	
Installation	Hook	
Mechanical Drawing		
Signal Definition		

Data & power interface	 <p style="text-align: center;">View from outside to radio</p>	Pin 1: PWR (9~16V DC) Pin 2: Power GND Pin 3: RXD Pin 4: Signal GND Pin 5: TXD
------------------------	---	--

Table 3.7 Default factory configuration for Radio RS400H3

Channel	Frequency
00	457.550MHz
01	458.050MHz
02	458.550MHz
03	459.050MHz
04	459.550MHz
05	460.550MHz
06	461.550MHz
07	462.550MHz
08	463.550MHz
09	464.550MHz
Customized frequency	410~470MHz

3.4 Radio whip antenna

The 410-470MHz radio whip antenna is to be installed on the TNC port to transmit or receive signal for the internal radio. This antenna is elastic whip structure, resistant to bending.

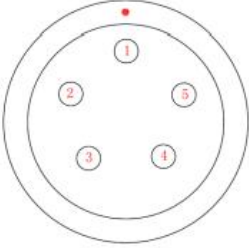

Figure 3.1 the 410-470MHz radio whip antenna

Table 3.8 Radio whip antenna technical specification

Technical Specification	
Frequency Range	410~470MHz
Bandwidth	60MHz
Polarization Mode	Vertical
Gain	2dBi
Input Impedance	50Ω
VSWR	≤2.5
Maximum Power	20W
Connector	TNC Male
Antenna Length	168mm
Antenna Weight	About 50g
Extreme Wind Speed	120 Km/h

4. Typical Applications

This chapter introduces typical applications of LUKA GNSS receiver, and solutions for some possible issues.



Install the radio antenna before switching the radio transceiver to transmit mode, or the radio transceiver may be damaged due to overheating. The energy to be transmitted cannot be emitted out without the antenna, which may cause the temperature rise and overheat of the radio module.

4.1 Base station operation



Figure 4.1 LUKA as a base - network mode

Table 4.1 Devices of LUKA as a base network mode

NO.	Device Name
1	LUKA GNSS receiver
2	Height measure accessory
3	GNSS antenna connector
4	Tribrach
5	Tripod

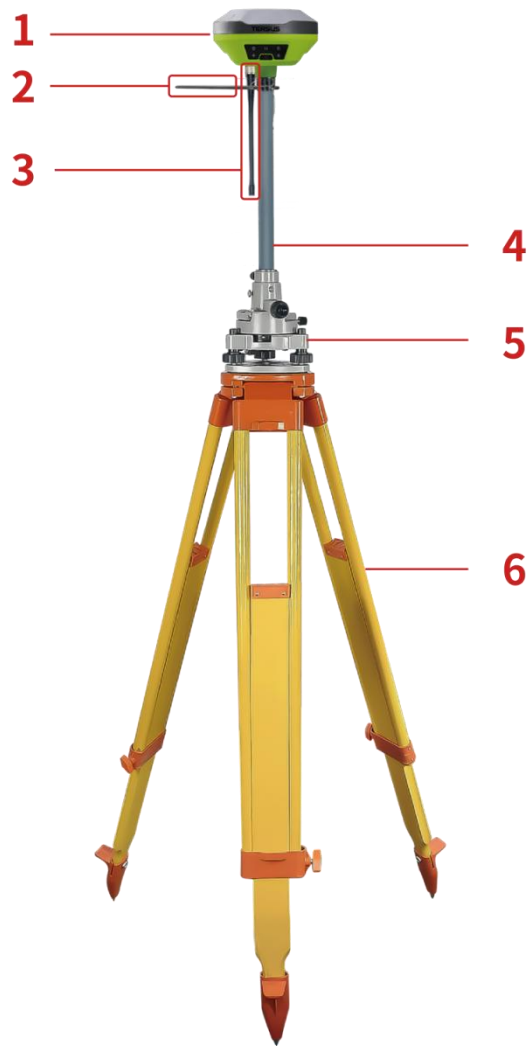

Figure 4.2 LUKA as a base - internal radio

Table 4.2 Devices of LUKA as a base internal radio mode

NO.	Device Name
1	LUKA GNSS receiver
2	Height measure accessory
3	410-470MHz radio whip antenna
4	Extension pole 30cm
5	Tribrach
6	Tripod

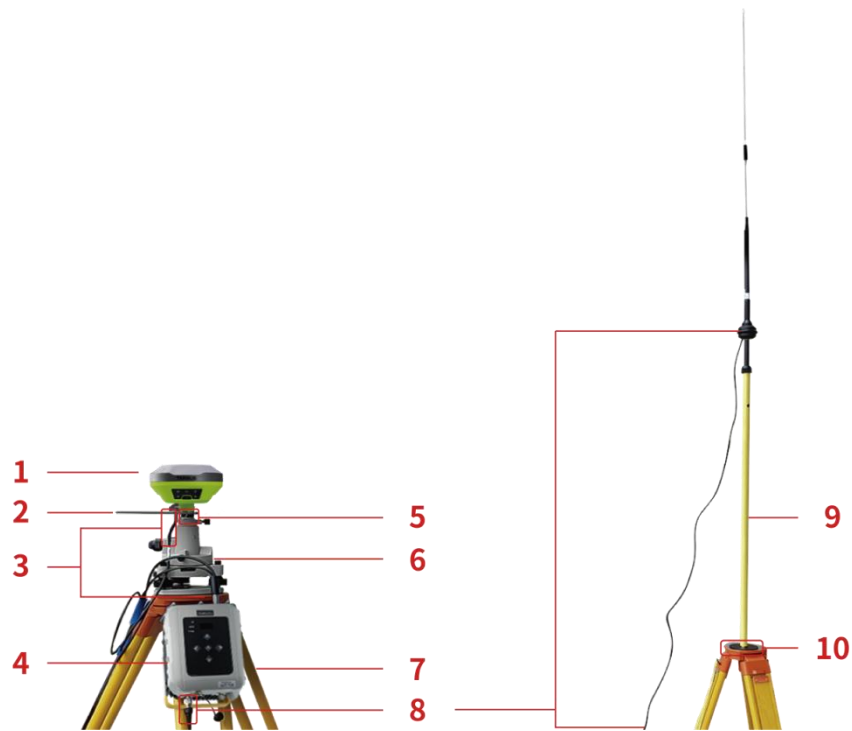

Figure 4.3 LUKA as a base – external radio

Table 4.3 Devices of LUKA as a base external radio mode

NO.	Device Name
1	LUKA GNSS receiver
2	Height measure accessory
3	Type-C to External-Radio-DC-5pin & Bullet-DC
4	External Radio RS400H3
5	GNSS antenna connector
6	Tribrach
7	Tripod
8	High Gain Radio Antenna
9	Telescopic pole for radio antenna
10	Metal plate for radio antenna

Note: Bullet-DC connects to ‘Bullet-DC to Alligator Clips’, and then clip to the external power supply with 12V output.

Detailed steps of software operation:

1. Set up LUKA according section 2.1 Setting up LUKA after all the components above are ready, ensure the battery has sufficient power and insert one SIM card when 4G/3G/2G network is required for operation;
2. Long press power button to power on LUKA;
3. Use NFC function to launch Nuwa app. While the screen of TC50 Controller is unlocked, put TC50 Controller close to the LUKA NFC logo. The Bluetooth pairs automatically after a beep and Nuwa is launched requesting to open the latest project. Click [OK] and start configuring LUKA from step 7. Also you can click [Cancel] to create a new project or open an existing project, and then start configuring LUKA from step 7.
4. If using an android device without NFC function, ensure LUKA is powered on, and launch Nuwa application on the android device. Click [Project] in the main interface to create a new project or open an existing project and connect LUKA manually.
5. Back to the main interface of Nuwa app, click [Device] -> [Connect] under an opened project.
6. Select [LUKA] for the Device Type, select [Bluetooth] for the Connect Type, click [Connect Config] to search and pair the Bluetooth address of LUKA, select [LUKA] for the Antenna and click [Connect] to enable communication between the android controller and LUKA.
7. Back to [Device] - > [Base], click [New] to create a new configuration for base.

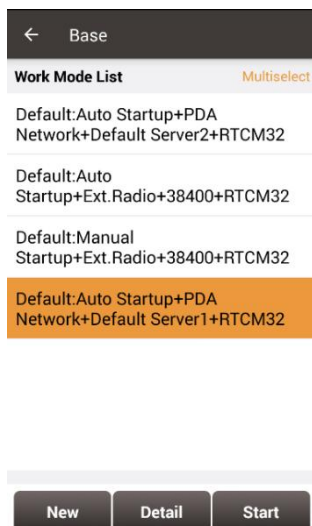

Figure 4.4 Base setting interface

8. Edit the base configuration for LUKA GNSS receiver. The startup mode can be chosen from auto start and manual start. If you choose manual start the base, you can manually type the base coordinate, or click the location icon to obtain the current base coordinate, or select a point from the control point library. The data link has four options: Receiver Network, PDA Network, Internal Radio and External Radio. Both the Receiver Network and PDA Network have three protocol options: Tersus Caster Service (TCS), Ntrip and TCP.

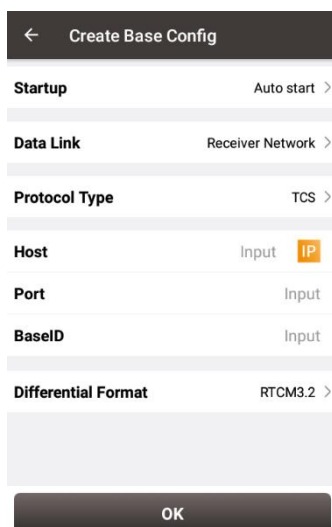

Figure 4.5 Base configuration - Receiver Network (TCS)

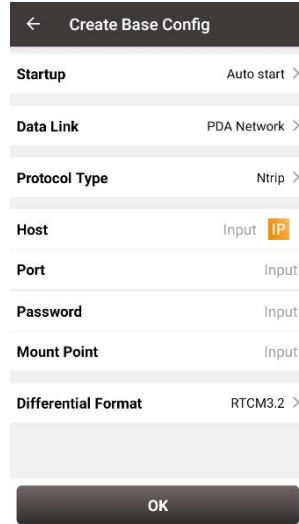

Figure 4.6 Base configuration – PDA Network (Ntrip)

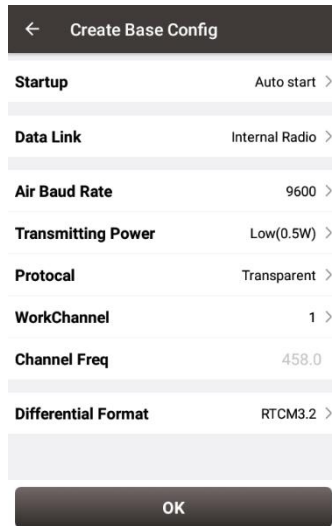

Figure 4.7 Base configuration - Internal Radio

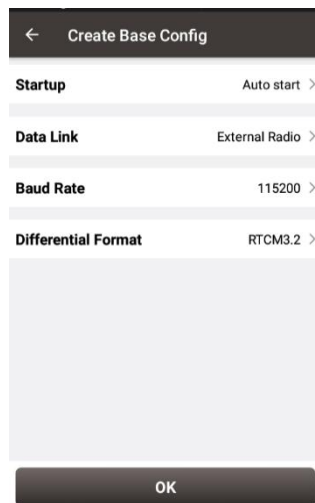

Figure 4.8 Base configuration - External Radio

9. After filling the information for the above configuration, click [OK]. Select this configuration in the work mode list and click [Start] to start data transmission for base which is shown as below.

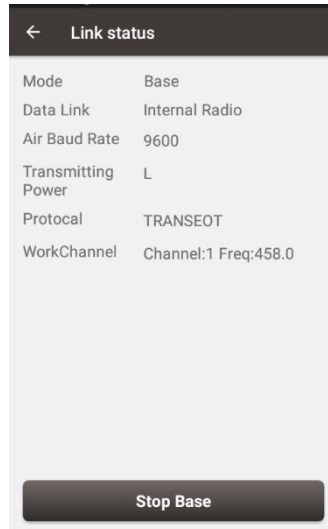

Figure 4.9 Link status of base using internal radio

4.2 Rover operation



Figure 4.10 LUKA as a Rover - Network Mode

Table 4.4 Devices of LUKA as a rover network mode

NO.	Device Name
1	LUKA GNSS receiver
2	Ranging pole
3	Bracket for TC50
4	TC50 Controller



Figure 4.11 LUKA as a Rover - Internal Radio

Table 4.5 Devices of LUKA as a rover internal radio mode

NO.	Device Name
1	LUKA GNSS receiver
2	410-470MHz radio whip antenna
3	Bracket for TC50
4	Ranging pole
5	TC50 Controller

Detailed steps of software operation:

1. Set up LUKA according section 2.1 Setting up LUKA after all the components above are ready, ensure the battery has sufficient power and insert one SIM card when 4G/3G/2G network is required for operation;
2. Long press the power button to power on LUKA;
3. Use NFC function to launch Nuwa app. While the screen of TC50 Controller is unlocked, put TC50 Controller close to the LUKA NFC logo. The Bluetooth pairs automatically after a beep and Nuwa is launched requesting to open the latest project. Click [OK] and start configuring LUKA from step 7. Also you can click [Cancel] to create a new project or open an existing project, and then start configuring LUKA from step 7.
4. If using an android device without NFC function, ensure LUKA is powered on, and launch Nuwa application on the android device. Click [Project] in the main interface to create a new project or open an existing project and connect LUKA manually.
5. Back to the main interface of Nuwa app, click [Device] -> [Connect] under an opened project;
6. Select [LUKA] for the Device Type, select [Bluetooth] for the Connect Type, click [Connect Config] to search and pair the Bluetooth address of LUKA, select [LUKA] for the Antenna and click [Connect] to enable communication between the android controller and LUKA.
7. Back to [Device] - > [Rover], click [New] to create a new configuration for base.

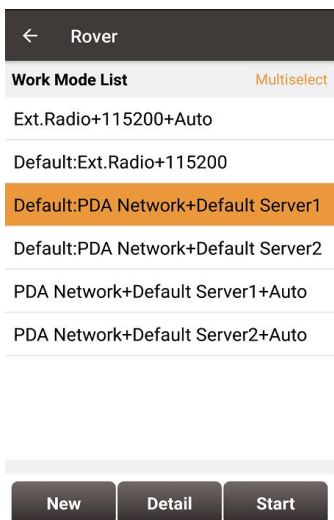

Figure 4.12 Rover setting interface

8. Edit rover configuration for LUKA GNSS receiver under different data link selections. The Receiver Network and PDA Network have three protocol options respectively: Ntrip, TCP and Tersus Caster Service (TCS).

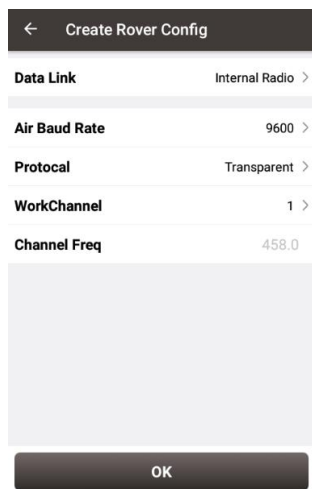

Figure 4.13 Rover configuration - Internal Radio

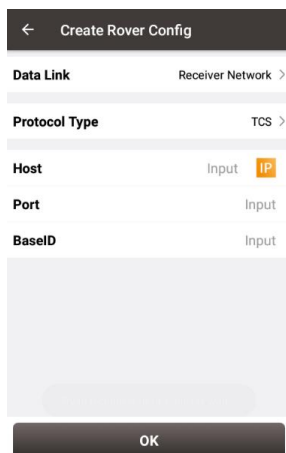

Figure 4.14 Rover configuration - Receiver Network (TCS)

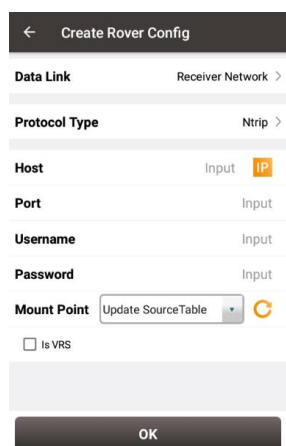

Figure 4.15 Rover configuration - Receiver Network (Ntrip)

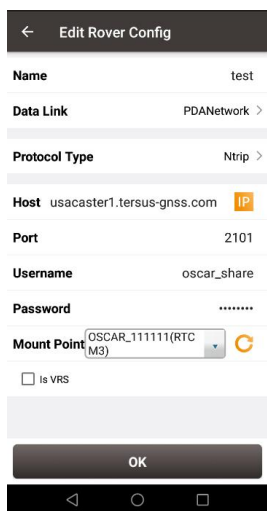

Figure 4.16 Rover configuration - PDA Network (Ntrip)

Note: Select PDANetwork when using cellular or Wi-Fi network of a PDA such as TC50 Controller.

9. After filling the information for the above configuration, click [OK]. Select this configuration in the work mode list and click [Start] to start data transmission for rover which is shown as below.

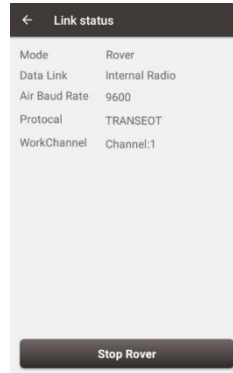

Figure 4.17 Link status of Rover using internal radio

4.3 Static survey

Before performing static survey, ensure the battery has sufficient power and insert one SIM card when 4G/3G/2G network is required for operation.

Detailed steps of software operation:

1. Long press the power button to power on LUKA;
2. Use NFC function to launch Nuwa app. While the screen of TC50 Controller is unlocked, put TC50 Controller close to the LUKA NFC logo. The Bluetooth pairs automatically after a beep and Nuwa is launched requesting to open the latest project. Click [OK] and start configuring LUKA from step 6. Also you can click [Cancel] to create a new project or open an existing project, and then start configuring LUKA from step 6.
3. If using an android device without NFC function, ensure LUKA is powered on, and launch Nuwa application on the android device. Click [Project] in the main interface to create a new project or open an existing project and

connect LUKA manually.

4. Back to the main interface of Nuwa app, click [Device] -> [Connect] under an opened project;
5. Select [LUKA] for the Device Type, select [Bluetooth] for the Connect Type, click [Connect Config] to search and pair the Bluetooth address of LUKA, select [LUKA] for the Antenna and click [Connect] to enable communication between the android controller and LUKA.
6. Click [Survey] -> [Static Survey], fill in the parameters of interval, cutoff angle, and etc. Then click [Start] to start static survey.

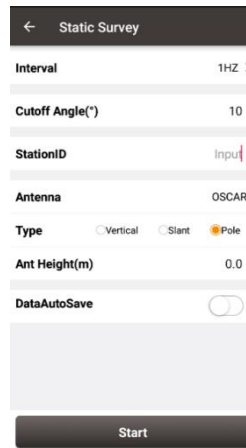

Figure 4.18 Static Survey configuration

7. If the DataAutoSave function is turned on, the static data is recorded automatically in the internal storage when power up LUKA next time. You can download data file refer to section 2.3.

4.4 Tilt survey and stakeout

Tilt function is only applicable for LUKA GNSS receiver Ultimate version under rover mode.

4.4.1 Tilt initialization

The tilt compensation of LUKA GNSS receiver Ultimate version is free of complex calibration. The tilt compensation will be initialized when the surveyor walks forward naturally for several meters after turning on the tilt compensation function. You can start tilt survey right after you walk to the survey point.

After the LUKA GNSS receiver Ultimate version is connect in Nuwa app, and we configure it working as a Rover. Click the device icon  on the top or click [Device] under the device functional group to enter the device information interface. Turn on the [Tilt Enable] on the device interface.

When tilt function is turned on, the tilt icon on the survey interface of NUWA app starts flashing red. At this time, walk a few steps ahead, tilt the pole at any direction, then the tilt icon turns [ON] which indicates tilt compensation is valid. Now you can start tilt survey.

When the tilt compensation is valid, click the Satellite info icon to view the detailed information of tilt compensation including tilt status, tilt direction, tilt angle, heading and their quality index. Among them, the tilt direct indicates which direction is tilted, that is, the angle between the projection of the ranging pole on the ground and the north direction after tilting; the tilt angle indicates the degree of tilt, that is, the angle between the tilted pole and the vertical direction; Heading indicates the surveyor's orientation (the facing of LUKA's back, we consider LUKA's panel is always facing the surveyor).

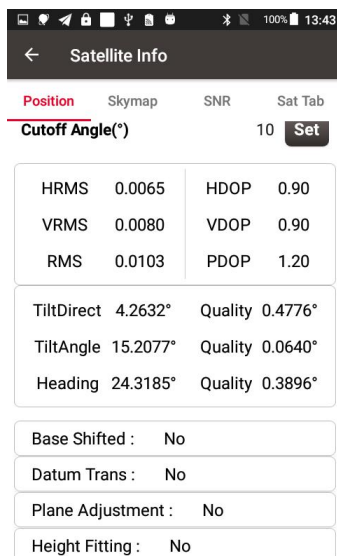

Figure 4.19 Detailed information of tilt compensation

4.4.2 Tilt survey

After turning on [Tilt Enable] and tilt initialization is finished, enter Survey interface and start tilt survey.

The tilt status is displayed at the top of the survey interface. When the tilt status is ON, it is considered that the tilt compensation accuracy is high and it is in a usable state. You can start survey using the tilted ranging pole. Please ensure that the antenna height setting is correct which will affect the tilt measurement results.

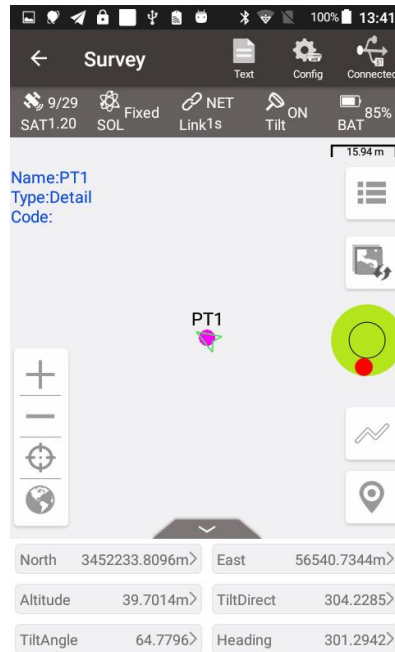

Figure 4.20 Tilt status is ON

When the status is displayed as N/A and blinking, it is considered that the accuracy of tilt compensation is reduced and it is in a state that is not recommended. This may be caused by the surveyor standing for too long, rotating the ranging pole, or hitting the ranging pole to the ground. When the status is N/A, you need to redo the initialization. Generally, you do not need to stand still, just hold the ranging pole and walk forward to the next point, the initialization is complete automatically.

Note: during the tilt survey, please keep the LUKA OLED display facing the surveyor as much as possible. Please do not rotate the pole or hit the pole to the ground, which will invalidate the initialization or affect the accuracy of the tilt compensation. In addition, during the tilt point survey, if it does not continue at the third epoch reached when it is set smoothing 5 epochs for surveying points, please check whether the tilt compensation is invalid. It is not allowed to continue to complete the survey in the case where the tilt initialization accuracy is low.

4.4.3 Tilt stakeout

After turning on [Tilt Enable] and tilt initialization is finished, enter the Point Stakeout or Line Stakeout interface and start tilt stakeout. The tilt state is also added at the top of the stakeout interface to indicate the current tilt available state.

During the tilt stakeout process, if you enter the threshold range of the stakeout setting, the software will display a virtual tilt ranging pole along with the beep sounds. It is drawn according to the tilt direction angle. When the pole is tilted in a certain direction among east, west, south and north, the virtual tilt ranging pole on the interface will also tilt in a certain direction.

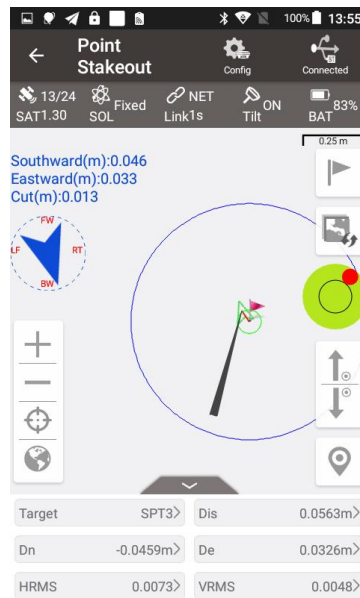

Figure 4.21 Point stakeout when tilt compensation is on

4.5 Issues and solutions

This section lists possible issues and effective solutions to solve them. Please read this section before contacting Tersus technical support.

1. LUKA GNSS receiver cannot receive satellite signals.

Solution:

- (1) Change the survey environment, and restart LUKA in an open space.

2. The internal UHF radio does not transmit data.

Solution:

- (1) Check whether the receiver is searching satellites normally;
- (2) Check whether the radio antenna is installed properly;
- (3) Check whether the radio module's protocol and channel are configured correctly and consistent with the configuration of rover's radio.

3. CORS network is not able to be logged in.

Solution:

Check whether the 4G SIM card is properly installed, and whether it can be used normally.

4. The communication between Nuwa and LUKA fails.

Solution:

- (1) Check whether the LUKA is powered on;
- (2) Re-search and pair the Bluetooth;
- (3) Upgrade Nuwa to the latest version.

5. There is no correction data for rover when using Ntrip work mode.

Solutions:

- (1) Check whether the IP address, port, user name, password is correct;
- (2) Check network. Try to use PDA/controller network to compare. Make sure there is no issue on the contact between the SIM card slot and the SIM card.
- (3) Obtain the SourceTable to check the receiver network module, ensure there is no issue on CORS service.
- (4) Try to log in with the same configuration and get a compared result if there is an extra receiver.
- (5) If still cannot log in, consult your CORS service provider.

6. How to export static observation data from LUKA?

Solutions:

- (1) Connect LUKA receiver with a computer through a Type-C to USB cable.
- (2) The computer detects the LUKA receiver as an external disk.
- (3) Open the Record folder, find the trs file and rinex file in its storage according to recording date.
- (4) Copy the static observation data and paste them to the designated folder in your computer.

7. How to calibrate the E-Bubble of LUKA receiver?

Solutions:

- (1) Firstly, install LUKA receiver on the tribrach of a tripod. Adjust the tribrach to enable the bubble to the center.
- (2) Next step, select <Adjust> in the Nuwa under Device Info -> E-Bubble to complete the calibration.

8. How to apply Geoid model file correctly?

Solutions:

- (1) Prepare the Geoid file at first and placed in the path of Internal storage\TersusSurvey\Geoid.
- (2) Next step, launch Nuwa and go to select Project - Current Project and edit Coordinate System. Find the Height Fitting-Adjust Method and select Geoid.
- (3) Last, select the file under Geoid List and apply it.

9. How to configure LUKA serial port output NMEA log?

Solutions:

- (1) Nuwa can configure to output NMEA by the NMEA option. It can be specified the Baud Rate, the kind of sentence.

10. A base receiver is working well, the rover receiver cannot get correction data, how to fix this?

Solutions:

- (1) Check whether the radio antenna connects well with receiver. Carefully check whether the interface is tightened.
- (2) Check whether the air baud rate, Protocol, Bandwidth, Frequency match right with that of the base receiver.
- (3) Switchover the radio frequency to avoid the possible interference from nearby devices.

11. The LUKA rover works at a short distance (not normal distance) at the radio mode?

Solutions:

- (1) Check whether the rover connects a radio antenna.

- (2) Adjust the radio of base at the high power gear.
- (3) Check the environment if there exists radio interference along the propagation line.

5. Terminology

Abbreviation	Description
AC	Alternating Current
BDS	BeiDou Navigation Satellite System
CMR	Compact Measurement Record
DC	Direct Current
eMMC	Embedded Multi Media Card
GLONASS	GLObal NAVigation Satellite System
GNSS	Global Navigation Satellite System
GPS	Global Positioning System
GSM	Global System for Mobile Communications
LED	Light Emitting Diode
OLED	Organic Light-Emitting Diode
PDA	Personal Digital Assistant
PPK	Post-Processing Kinematic
PPS	Pulse Per Second
QZSS	Quasi-Zenith Satellite System
RINEX	Receiver Independent Exchange format
RMS	Root Mean Squares
RTK	Real-Time Kinematic
RTCM	Radio Technical Commission for Maritime Services
SIM	Subscriber Identification Module
TCP	Transmission Control Protocol
UAV	Unmanned Aerial Vehicle, drone
UMTS	Universal Mobile Telecommunications System
USB	Universal Serial BUS
UTC	Universal Time Coordinated

Proprietary Notice

All Information in this document is subject to change without notice and does not reflect the commitment on Tersus GNSS Inc. No part of this manual may be reproduced or transmitted by all means without authorization of Tersus GNSS Inc. The software described in this document must be used in terms of the agreement. Any modification without permission from Tersus GNSS Inc. is not allowed.